

Sept 444 1121

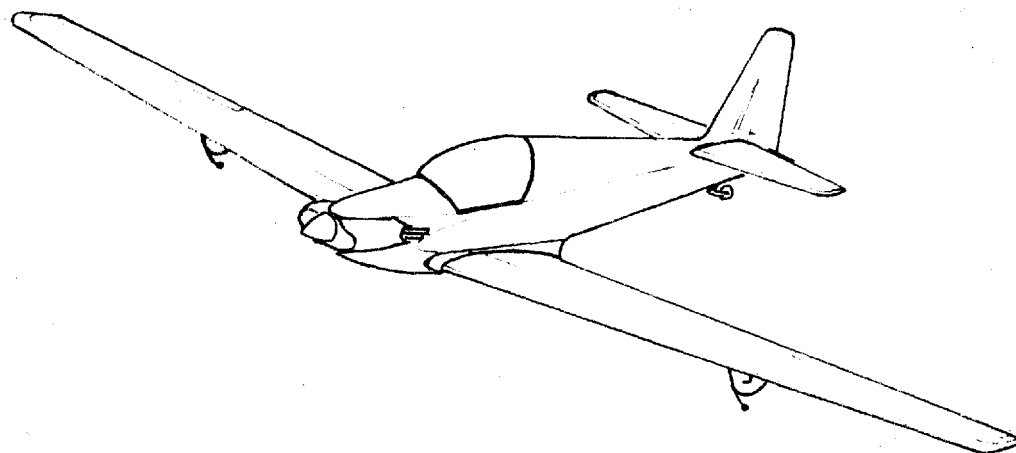

FOURNIER RF4D

Einzelteilkatalog

- Parts Catalogue

- Catalogue de Pieces détachées

Ausgabe: Februar 1987

SPORTAVIA - Pützer
GmbH u. Co. KG.
D-5377 Post Schmidtheim
Flugplatz Dahlemer Binz
Telefon: 02447-277-278
Tlex : 833602 spkg

Inhaltsverzeichnis - Contents



Seite
Page

1. Ausrüstung - Equipment - Equipement	
1.1 Instrumente - Instruments	4
1.2 Elektr. Anlage - Electric System - Installation électrique	6
1.3 Anschnallgurte - Safety harness	8
1.4 Verschiedenes - Various parts - pieces diverses	9
2. Rumpf - Fuselage	
2.1 Propeller - Hélice	10
2.2 Triebwerk - Engine - Moteur	11
2.3 Brandspant - Firewall - Cloison pare feu	15
2.4 Fahrwerk - Gear - Train	17
2.5 Handanlasser - Starter - Lanceur	25
2.6 Kraftstoffanlage - Fuel system - Circuit carburant	27
2.7 Flächen- und Leitwerksanschlüsse - Wing and tailplane - mountings - Ferrures fixation	29
2.8 Steuerung - Control system - Commandes	31
2.9 Haube - Canopy - Verrière	35
2.10 Sporn - Tail wheel - roulette de queue	37
2.11 Verschiedenes - Various parts - pieces diverses	40
3. Tragfläche - Wing - Voilure	
3.1 Steuerung - Control system - Commandes	41
3.2 Störklappen - Spoiler - Aérofreins	45
3.3 Kabinenbelüftung - Cabin ventilation - Ventilation cabine	47
3.4 Stützbügel - Outrigger - Balancines	48
3.5 Verschiedenes - Various parts - diverses	50
4. Leitwerk - Tailplane - Empennage	
4.1 Seitenleitwerk - Vertical tail - Vertical	51
4.2 Höhenleitwerk - Empennage - Horizontal	53

SPORTAVIA-Pützer
GmbH u. Co. KG.
D-5377 Post Schmidtheim

1. Ausrüstung - Equipment - Equipement
1.1 Instrumente - Instruments

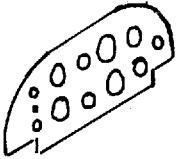
FOURNIER
- RF 4 D -
1.1

	Serien-No	Teil - Item - pièce	Anzahl Quantity
	3.25.12	Instrumentenbrett Instrument panel Tableau de Bord nu	1
	3.25.14	Befestigungswinkel Panel support Support inferieur	2
APEX AVA 2301	3.25.11/4	Gummipuffer Shock absorber Amortisseur tableau de bord	4
Winter 6 FMS 3		Fahrtmesser 0-250 km/h ASI 0-200 mph Anémometre 0-250 km/h	1
Winter 4 HM 6		Höhenmesser 0-6.000 m Altimeter 0-20.000 feet Altimetre 0-6.000 m	1
Winter 4 FGH 10		Feinhöhenmesser 0-10.000 m Sensitive altimeter 0-30.000 feet Altimetre Sensible 0-10.000 m	1
Winter 5 VM		Variometer \pm 10 m/s Variometer \pm 2.000 feet/min Variometre \pm 10 m/s	1
Vion typ 112		Kompass Compass Leuker Compass	1

SPORTAVIA - Pützer
GmbH u. Co. KG.
D-5377 Post Schmidtheim

1. Ausrüstung - Equipment - Equipement
1.1 Instrumente - Instruments

FOURNIER
- RF 4 D -
1.1

	Serien-No	Teil - Item - pièce	Anzahl Quantity
Winter		Querneigungsmesser Bank indicator Controleur de vol	1
Jäger 44580		Drehzahlmesser 0-4.000 U/mm RPM - indicator Tachymetre	1
VDO		Öldruckmesser 0-5 kp/cm Oil pressure indicator Manometre huile	1
VDO		Ölthermometer 0-120° C Oil temperature indicator Thermometre huile	1

SPORTAVIA - Pützer
 GmbH u. Co. KG.
 D-5377 Post Schmidtheim

1. Ausrüstung - Equipment - Equipement
 1.2 Elektr. Anlage - Electric System

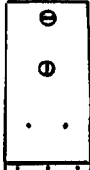
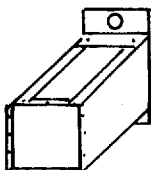

FOURNIER
 RF 4 D -
 1.2



	Serien-No	Teil - Item - pièce	Anzahl Quantity
Siemens 9 T wck 4 g 12 V - 39 x 9		Summer Horn Vibreur	1
Fromm		Druckschalter Test button bouton test	1
Labinal 30 V 10 A Type 1020 B		Zündschalter Ignition switch Contact moteur	1
	4.25.15	Batteriekastenklappe Battery panel Porte support Batterie	1
	4.25.16	Batteriekasten Battery box Boite à Batterie	1
Sonnenschein 3 G x 3/F 6 Volt 2,6 Ah		Batterie Battery Batterie	2
Sonnenschein dryfit-Automatic 6 V/350 m A Größe 1		Batterie - Ladegerät Charger set Chargeur	
Fromm		Stecker und Steckdose Plug and wall socket Fiche et Prise	1

SPORTAVIA - Pützer
 GmbH u. Co. KG.
 D-5377 Post Schmidheim

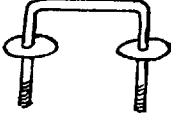
1. Ausrüstung - Equipment - Equipement
 1.3 Ansnallgurte - Safety harness

FOURNIER
 - RF 4 D -
 1.3

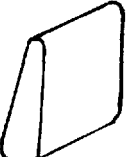
	Serien-No	Teil - Item - pièce	Anzahl Quantity
EFA 602.124	4.26.01/6	Ansnallgurte Safety harness Ceinture	1
	3.26.11	Gurthalterung Harness support Attache ceinture	2
	3.26.13	Haltelasche Joint Chape	2
	4.26.11	Gurthalterung Harness support Attache ceinture	2

SPORTAVIA - Pützer GmbH u. Co. KG. D-5377 Post Schmidtheim	1. Ausrüstung - Equipment - Equipement 1.4 Sonstiges - Various parts	FOURNIER - RF 4 D - 1.4	
	Serien-No	Teil - Item - pièce	Anzahl Quantity
	4.26.14	Rückenlehne Back rest Dossier	1
	4.26.15	Fallschirmersatz Parachute substitute Logement parachute	1
	4.26.16/l 4.26.16/r	Seitenverkleidung Side cover Habillage latéral	1 1
		Sitzkissen Seat cushion Coussin siège	1
		Rückenkissen Back rest cushion Coussin dossier	1
		Sitz-Rückenkissen Seat-back cushion Coussin siège-dossier	1

SPORTAVIA - Pützer
 GmbH u. Co. KG.
 D-5377 Post Schmidtheim

2. Rumpf - Fuselage
 2.1 Propeller

FOURNIER
 - RF 4 D -
 2.1

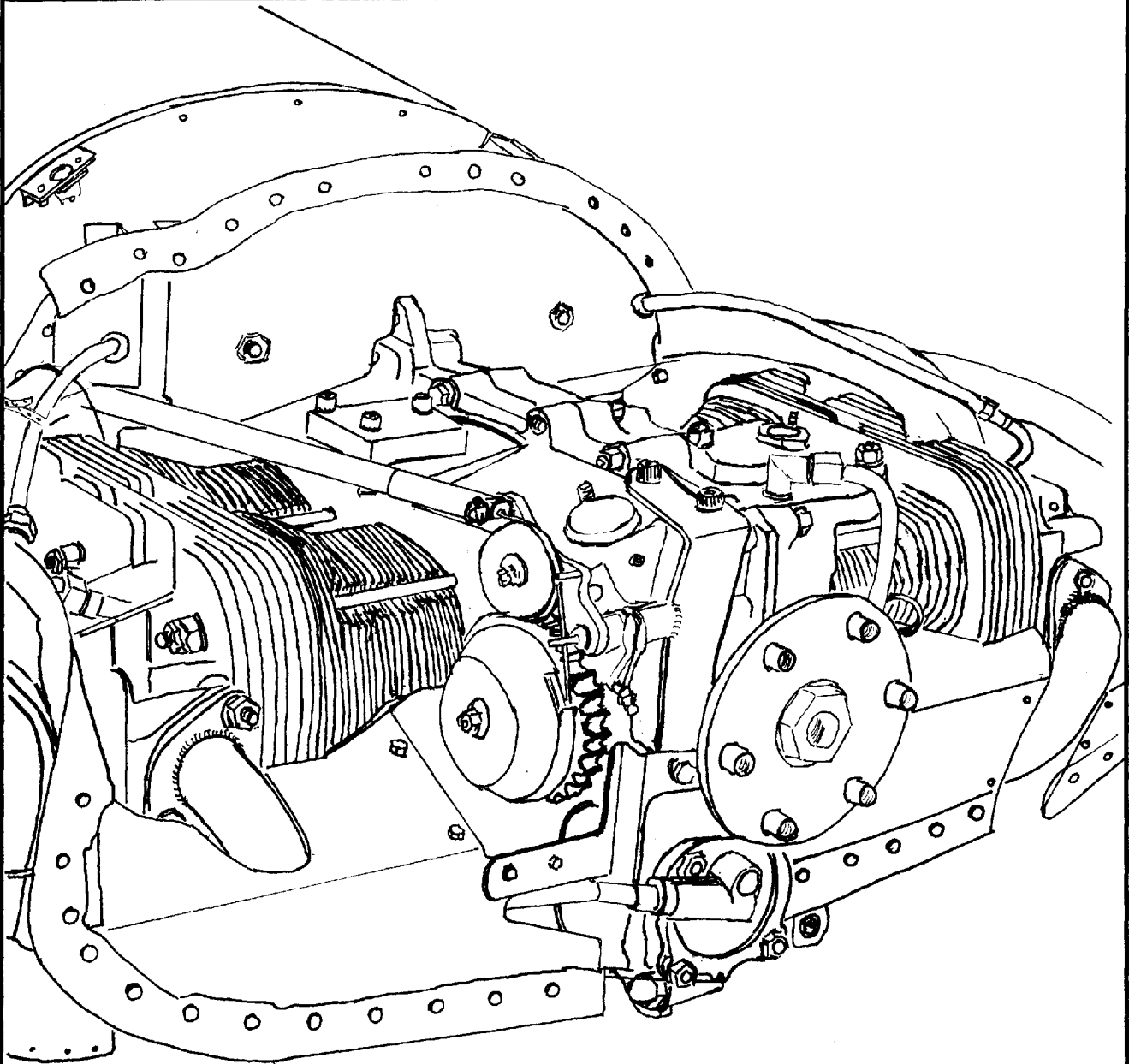





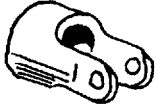
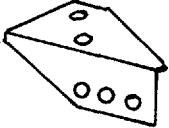

	Serien-No	Teil - Item - pièce	Anzahl Quantity
HOCO FH2/S11- 133-70-6,8 L		Luftschraube Propeller Hélice	1

SPORTAVIA - Pützer
 GmbH u. Co. KG.
 D-5377 Post Schmidtheim

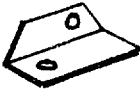
2. Rumpf - Fuselage
 2.2 Triebwerk - Engine - Moteur



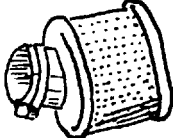



FOURNIER
 - RF 4 D -
 2.2

	Serien-No	Teil - Item - pièce	Anzahl Quantity
	4.22.04/D 4.22.04/E	Gabelkopf Crown joint Chape support	2 2
	4.50.10/A	Gaszughalterung Throttle control support Support arret de gaine gaz	1
	4.5010/B	Gegenplatte Counter plate Contre-plaque	1
	3.50.21	Starterzughalterung Mixture control support Support gaine starter	1
	3.50.42	Lasche Joint Manille	1
	3.50.43	Zugfedern Spring Ressort	1
	3.50.45	Ölentlüftungsrohr Oil vent Tuyau reniflard	1
	3.50.48	Luftfilter Induction filter Filtre à air	1

SPORTAVIA - Pützer
GmbH u.Co. KG.
D-5377 Post Schmidtheim

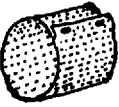
2. Rumpf - Fuselage
2.2 Triebwerk - Engine - Moteur

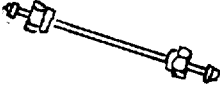
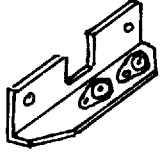



FOURNIER
-RF 4 D -
2.2

	Serien-No	Teil - Item - pièce	Anzahl Quantity
	3.50.53	Flansch Flange Buse	1
	3.50.54	Deckel Cover Couvercle	1
	3.50.55	Sieb Filter Filtre	1
	3.50.47	Gewindebuchse Screw set raccord	1
	3.50.46	Öldruckleitung Oil pressure line tuyau pression d'huile	1
	3.60.11	Haltewinkel für Mikro-Schalter Microswitch support Support Micro-contact	1
	3.60.12	Halteplatte für Mikro-Schalter Microswitch mounting Support isolant	1
	3.60.13	Schaltflasche Contact joint Came	1

SPORTAVIA - Pützer
GmbH u. Co. KG.
D-5377 Post Schmidtheim

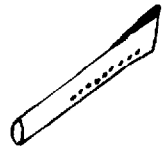
2. Rumpf - Fuselage
2.2 Triebwerk - Engine - Moteur

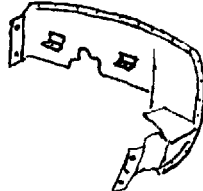
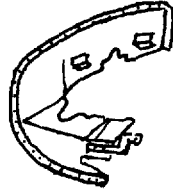

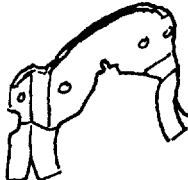
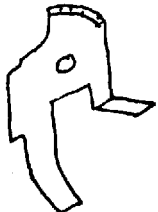
FOURNIER
- RF 4 D-

	Serien-No	Teil - Item - pièce	Anzahl Quantity
	3.50.22/A1	Auspuffrohr	1
	3.50.22/B1	Exhaust manifold	1
	3.50.23/Ar	Pipes d'échappement	1
	3.50.23/Br		1
	3.50.13/A	Schalldämpfer links/rechts Silencer left/right	2
	3.50.13/B	Silencieux	2
	4.50.14	Schelle Clamp Collier	2
	4.50.16	Luftleitblech links Air deflector left Déflecteur gauche	1 1
	4.50.17	Luftleitblech rechts Air deflector right Déflecteur droit	1
	3.50.65	Luftleitblech vorne links Air deflector front left Déflecteur avant gauche	1
	3.50.60	Luftleitblech hinten Air deflector aft Déflecteur arrière	1
	3.50.61	Luftleitblech hinten links Air deflector aft left Déflecteur arrière gauche	1

SPORTAVIA - Pützer
GmbH u. Co. KG.
D-5377 Post Schmidtheim

2. Rumpf - Fuselage
2.2 Triebwerk - Engine - Moteur



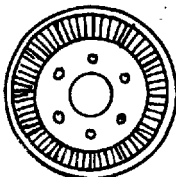
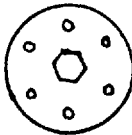
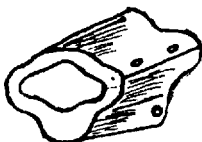



FOURNIER
- RF 4 D -
2.2



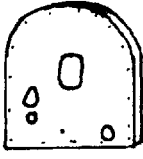
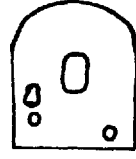

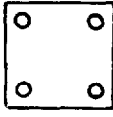

	Serien-No	Teil - Item - pièce	Anzahl Quantity
	3.50.62	Luftleitblech hinten rechts Air deflector aft right Déflecteur arrière droit	1
	3.50.40	Spinner Spinner Cone	1
	3.50.39	Spinnerscheibe Spinner disk Flasque de cone	1
	3.50.20	Sicherungsscheibe Securing disk Disque Frein	1
	4.50.22	Motorhaube (obere/untere) Cowling (upper/lower) Capots (supérieur-inférieur)	1
Jacottet		Gaszug Throttle control Commande de gaz	1
Küster u. Co.		Starterklappenzug Mixture control Commande de starter	1
Marquardt 0925-0201 10 A 250 V		Mikro-Schalter Microswitch Micro-contact	1

SPORTAVIA - Pützer
GmbH & Co. KG.
D-5377 Post Schmidtheim

2. Rumpf- Fuselage
2.3 Brandspant - Firewall - Cloison pare feu

FOURNIER
- RF 4 D -
2.3

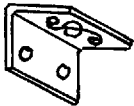
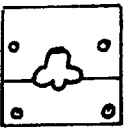
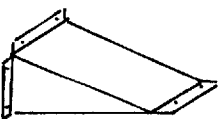
	Serien-No	Teil - Item - pièce	Anzahl Quantity
	4.22.01/43	Brandspantabdeckung Firewall cover Cloison pare feu	1
	4.22.01/44	Zwischenblech Aluminium sheet Tole intermediaire	1
	4.22.01/45	Asbestplatte Asbestos sheet Feuille d'Amiante	1
	4.22.01/47	Zwischenblech Aluminium sheet Tole	4
	4.22.01/48	Asbeststück Asbestos sheet Plaque d'amiante	2
	4.22.01/11	Magnetabdeckhaube Magneto cowling Carter Magnéro	1
	4.22.01/49	Abdeckplatte Cover plate Plaquette	1
	4.22.04/F	Buchse - Motorenaufhängung Engine mounting set Canon - fixation moteur	4

SPORTAVIA - Pützer GmbH u. Co. KG. D-5377 Post Schmidtheim		2. Rumpf - Fuselage 2.3 Brandspant - Firewall - Cloison pare feu	FOURNIER - RF 4 D 2.3
	Serien-No	Teil - Item - pièce	Anzahl Quantity
	4.22.04/B1	Winkel für Motorenaufhängung Engine mounting profile	4
	4.22.04/Br	corniere support moteur	4
	4.22.04/G	Motorenaufhängung Engine mounting Support silenbloc	4
	4.22.04/C	Gegenplatte Counter plate Contre-plaque	4
	4.22.04/A	Gegenplatte Counter plate Contre-plaque	4
	4.22.04/H	Befestigungswinkel Cowling mounting profile Corniere fixation capot	4
	3.22.16	Kabeldurchführung Opening for cable Fibre passage cables	1
	4.22.30	Luftaustritt Cooling air exhaust Sortie d'air	1
	3.22.34	Brandhahnstütze Fuel valve support Support filtre d'essence	1





SPORTAVIA - Pützer
 GmbH & Co. KG.
 D-5377 Post Schmidtheim

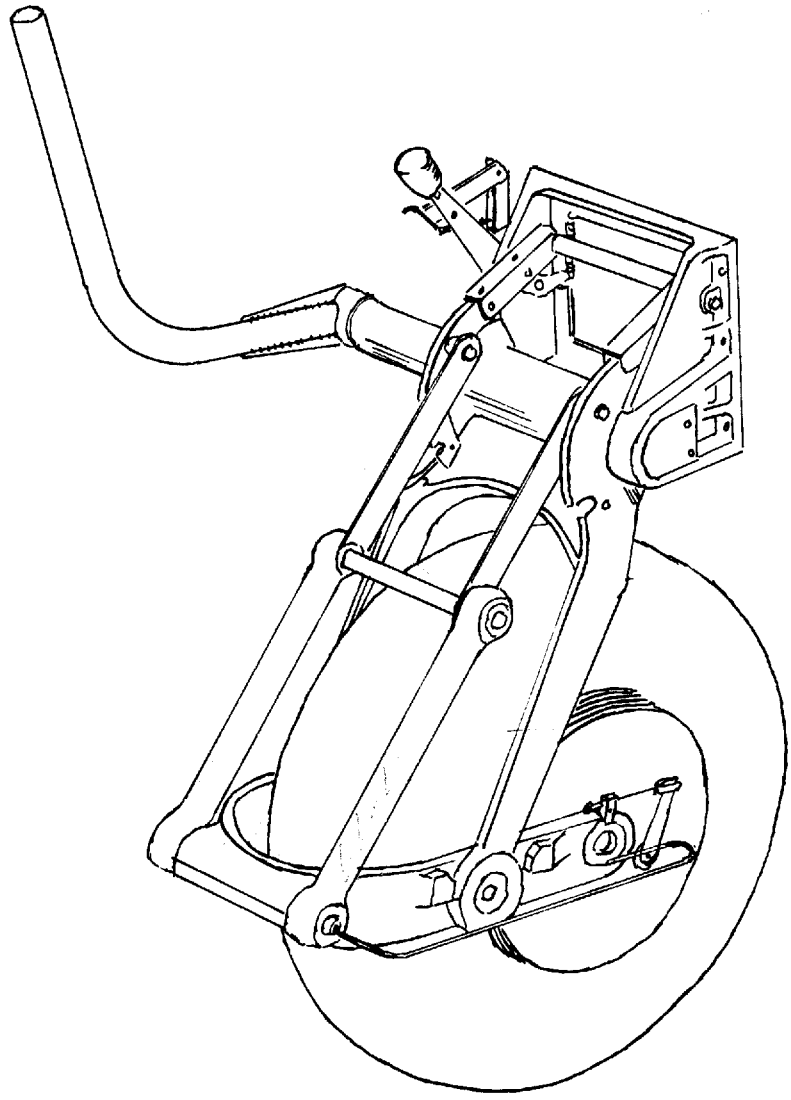

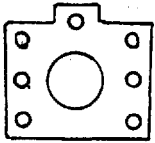
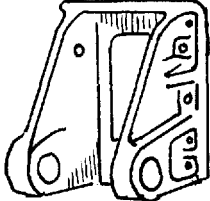
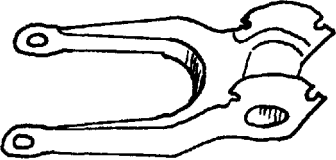
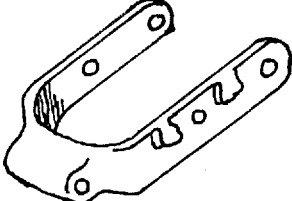

2. Rumpf - Fuselage
 2.4 Fahrwerk - Gear - Train

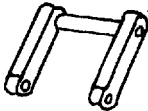
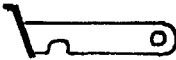



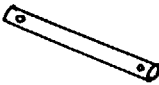
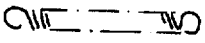
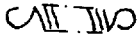
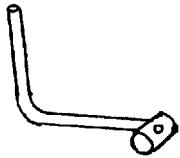
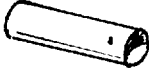

FOURNIER
 - RF 4 D -
 2.4









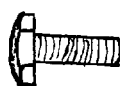

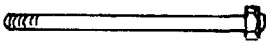
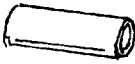
	Serien-No	Teil - Item - pièce	Anzahl Quantity
Dunlop 380 x 150	4.40.01/42	Decke Tyre Pneu	1
Dunlop	4.40.01/41	Schlauch Tube Chambre	1
	3.40.14/3	Felge Felloe Jante	1

SPORTAVIA - Pützer GmbH u. Co. KG. D-5377 Post Schmidtheim	2. Rumpf - Fuselage 2.4 Fahrwerk - Gear - Train	FOURNIER - RF 4 D - 2.4	
	Serien-No	Teil - Item - pièce	Anzahl Quantity
	3.40.11	Gegenplatte Counter plate Contre - plaque	1
	4.40.10	Grundgestell Gear base Support train	1
	4.40.12	Radgabel Gear main support Fourche de Train	1
	4.40.13	Gabel Wheel support Balaneier	1
	3.40.16	Winkel für Sicherungshebel Mounting for lock lever Equerre pour sécurité	1
	3.40.15	Verriegelung Gear lock Verrouillage	1
	3.40.17	Sicherungshebel Safety lever Levier de sécurité	1
	3.40.18	Nocken Cam Came	1

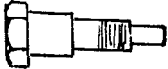
	Serien-No	Teile - Item - pièce	Anzahl Quantity
	3.40.19	Nockenlager Cam bearing Coussiner de came	1
	3.40.20	Handhebel Lock lever Levier de came	1
	3.40.22	Achse für Verriegelung Gear lock shaft Axe de Verrouillage	1
 	3.40.23/A 3.40.23/B	Spiralfeder Spring Ressort	1 1
	3.40.25	Fahrwerkshebel Gear lever Levier de Train	1
	3.40.26	Achse Gear shaft Axe	1
	3.40.27	Drehstabhalterung Torsion spring support Support ressort de torsion	1
	3.40.32	Buchse Set Entretoise	2

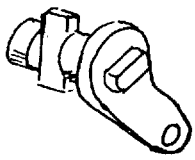
	Serien-No	Teile - Item - pièce	Anzahl Quantity
	3.40.28	Drehstabarretierung Torsion spring mounting Fixation ressort de torsion	1
	3.40.29	Federblatt Torsion spring Ressort de torsion	7
	3.40.30	Schelle Clamp Collier	1
	3.40.31	Lasche Joint Rallonge	2
	3.40.33	Schraube Bolt Boulon	2
	3.40.34	Unterlegscheibe Washer Rondelle	2
	3.40.35	Distanzrohr Distance tube Entretoise	1
	3.40.36	Gewindebolzen Bolt Axe Fileté	2



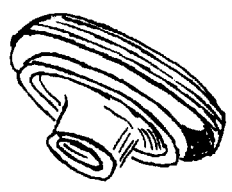
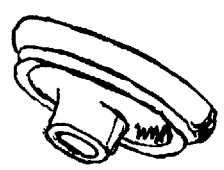
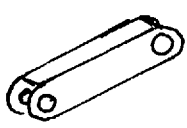





	Serien-No	Teile - Item - pièce	Anzahl Quantity
	3.40.37	Gewindebuchse Screw set Axe taraudé	2
	3.40.38	Achse Shaft Axe	1
	3.40.39	Rohr Tube Tube	1
	3.40.40	Bremsflansch Brake disk Flasque de frein	1
	3.40.41	Distanzrohr Distance tube Entretoise	1
	3.40.42	Fiberscheibe Fiber disk Rondelle Fibre	2
	3.40.43	Distanzrohr Distance tube Entretoise	2
	3.40.44	Bolzen Bolt Boulon axe	1





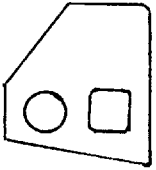

	Serien-No	Teile - Item - pièce	Anzahl Quantity
	3.40.45	Hebel Brake lever Came et levier	1
	3.40.46/A1 3.40.46/Ar	Klappenführung Gear flap guidance Guide ouverture trappe	1 1
	3.40.52	Lager Bearing Cuvette	2
	3.40.54 3.40.55	Segment Segment Segment	1 1
	3.40.57	Lager Bearing Cuvette	2
	3.40.58	Flansch Flange Flasque	1
	3.40.59	Flansch Flange Flasque	1
	3.40.63/A1 3.40.63/Br	Strebe Joint Element de Verrouillage	2

SPORTAVIA - Pützer
GmbH u. Co. KG.
D-5377 Post Schmidtheim

2. Rumpf - Fuselage
2.4 Fahrwerk - Gear - Train

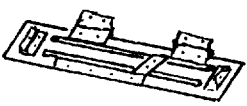
FOURNIER
- RF 4 D -
2.4



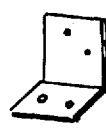
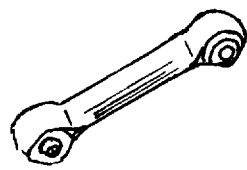



	Serien-No	Teile - Item - pièce	Anzahl Quantity
	3.40.70	Nocken Cam Came	1
	3.40.71	Nockenspindel Camshaft Axe de came	1
	3.40.75	Buchse Set Canon	1
	3.40.80	Buchse Set Canon	1
	3.40.89	Deckel Cover Cuverte	2
	4.40.94	Gewindebolzen Bolt Vis Teton	2
	3.40.95/Al	Abdeckplatte Cover plate	1
	3.40.95/Br	Toile d'etanchéiré	1
	3.22.62	Radkasten Gear cowling Carter de roue	1

	Serien-No	Teile - Item - pièce	Anzahl Quantity
	3.22.56	Spiralfeder Spring Ressort	4
	3.22.55	Federaufhängung Spring mounting Support ressort	4
	3.22.53 3.22.54	Fahrwerksklappe Gear flap Trappe	1 1
	4.22.31 4.22.32	Rumpfverkleidung Lower cowling Carenage fuselage	1 1
	3.22.73	Knüppelsack Stick bag Soufflet	1
	3.22.74	Öse Ring Bride	4
	3.60.14	Befestigungswinkel für Mikro-Schalter Microswitch mounting Support micro	1
	4.40.01/43	Fahrwerksgummi Shock absorber Extenseur	2

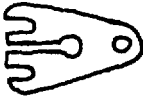
SPORTAVIA - Pützer
 GmbH u. Co. KG.
 D-5377 Post Schmidtheim

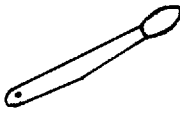
2. Rumpf - Fuselage
 2.5 Handanlasser - Starter - Lanceur

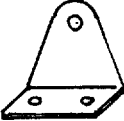
FOURNIER
 - RF 4 D -
 2.5

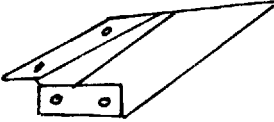
	Serien-No	Teil - Item - pièce	Anzahl Quantity
	4.50.80a	Haltewinkel Mounting profile Corniere support	1
	4.50.80b	Gegenplatte Counter plate Contre plaque	1
	4.50.80c	Distanzscheibe Distance disk Rondelle d'épaisseur	3
	4.50.80d	Anlasserhebel Starter lever Levier de Lanceur	1
	4.50.81	Radkastenverstärkung (für Montage durch den Halter selbst) Reinforcement of gear cowling (for assembly by the owner himself) Renforcement structural du carter de roue	1
	4.50.82	Verstärkungswinkel Reinforcing profile Corniere de renforcement	1
	4.50.83 4.50.83a	Führungsleiste Guidance Guide	1 1
	4.50.84	Kasten für Anlasserritzel Box for starter pinion boite du lanceur	1

SPORTAVIA - Pützer
 GmbH u. Co. KG.
 D-5377 Post Schmidtheim

2. Rumpf - Fuselage
 2.5 Handanlasser - Starter - Lanceur

FOURNIER
 - RF 4 D -
 2.5

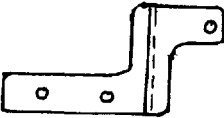
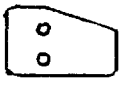

	Serien-No	Teil - Item - pièce	Anzahl Quantity
	4.50.85	Haltelasche Luftleitblech rechts Joint air deflector right Support déflector avant droit	1
	4.50.86	Verstärkungsblech Reinforcing sheet Tole de renforcement	1





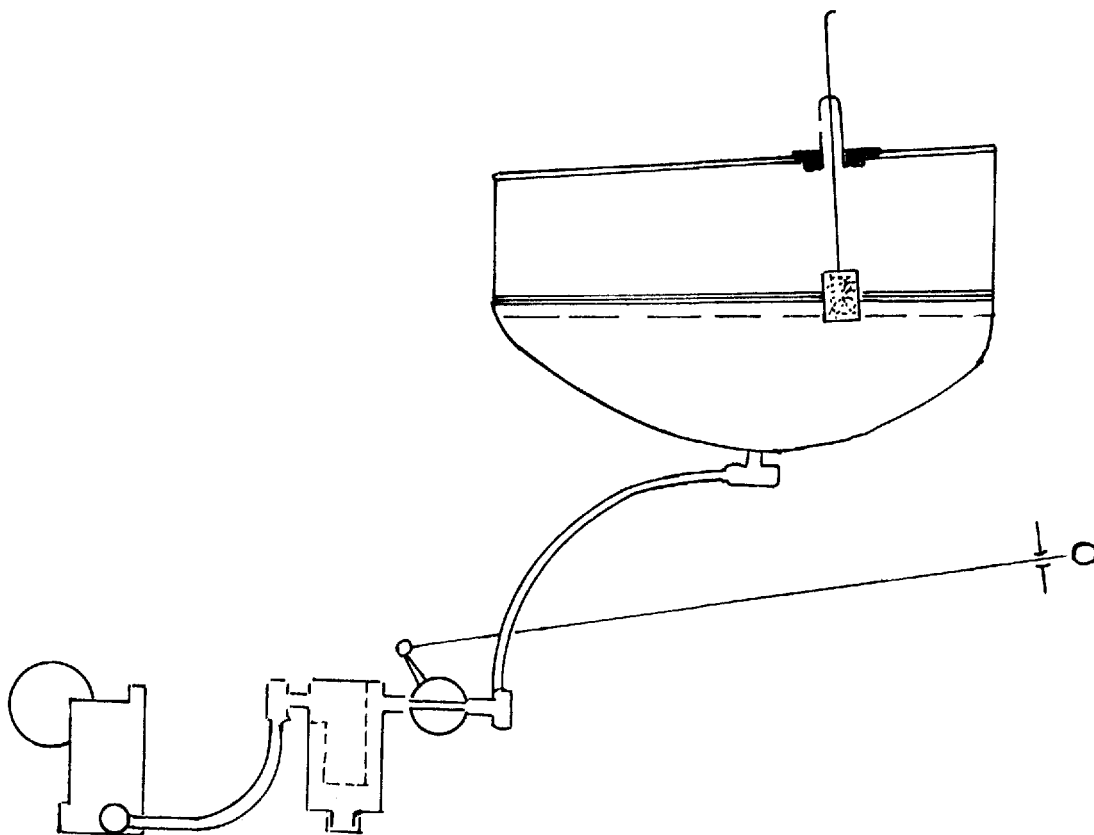

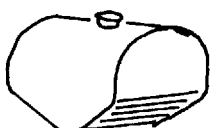
SPORTAVIA - Pützer
GmbH u. Co. KG.
D-5377 Post Schmidtheim

2. Rumpf - Fuselage
2.6 Kraftstoffanlage - Fuel system -
Circuit carburant

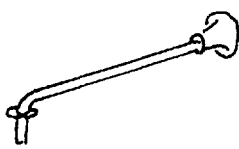
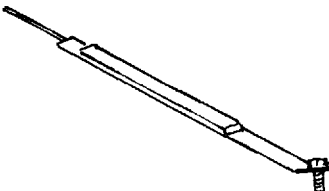
FOURNIER
- RF 4 D -
2.6



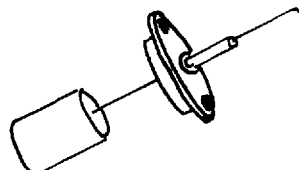





	Serien-No	Teile - Item - pièce	Anzahl Quantity
	4.51.20	Tank Fuel tank Réservoir	1
	4.51.01/8	Korkunterlage Cork sheet Liège	1
Superflexit 7152	4.51.01/11	Kraftstoffschlauch	1
" 2153	4.51.01/12	Fuel line Durite	1
Le Bozec No A 30033	4.51.01/9	Brandhahn Fuel cock Robiner filtre	1

SPORTAVIA - Pützer GmbH u. Co. KG. D-5377 Post Schmidtheim	2. Rumpf - Fuselage 2.6 Kraftstoffanlage - Fuel system - Circuit carburant	FOURNIER - RF 4 D - 2.6	
	Serien-No	Teile - Item - pièce	Anzahl Quantity
	3.25.13	Befestigungswinkel Mounting profile Equerre de fixation	2
	4.51.25	Zugstange Cock drive Commande robinet	1
	4.51.15	Haltegurt Tank mounting strip Sangle	2
	4.51.12	Buchse Set Rondelle de pente	2
	3.51.14	Anschlußschraube mit Sieb Connection plug with filter Boulon raccord avec crépine	1
	4.51.40	Anschlußschraube Connection plug Boulon raccord	1
	3.51.12	Tankdeckel mit Vorratsmesser Tank plug with storage indicator Bouchon jauge	1
	4.51.13	Kunstflugtankverschluß Tank plug for aerobatics Bouchon pour acrobaties	1

SPORTAVIA - Pützer
GmbH u. Co. KG.
D-5377 Post Schmidtheim

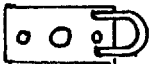
2. Rumpf - Fuselage
2.7 Flächen- und Leitwerksanschlüsse - Wing
and tailplane mountings - Ferrures de Fixation

FOURNIER
- RF 4 D -

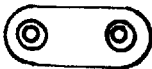





	Serien-No	Teile - Item - pièce	Anzahl Quantity
	3.00.11	Flächenanschlußbolzen Wing mounting bolt Boulon de Fixation d'aile	2
	3.00.12/A	Gegenplatte Counter plate Contre-plaque	1
	3.00.12/B	Gegenplatte mit Fallschirmöse Counter plate with ring Contre-plaque avec anneau	1
	4.00.03/B	Flächenanschlußplatte Wing mounting plate Fixation d'aile arriére	2
	4.00.03/C	Flächenanschlußplatte	1
	4.00.03/D	Wing mounting plate Fixation d'aile arriére	1
	4.00.04/B	Kielflossenbefestigung Vertical tail mounting Fixation de dérive	1
	4.00.04/I	Gegenplatte	1
	4.00.04/H	Counter plate Contre-plaque	1
	4.00.04/G	Befestigungsplatte	1
	4.00.04/F	Mounting plate Plaque de Fication	1

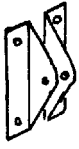
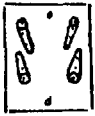
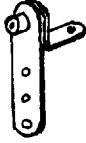
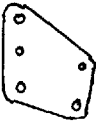

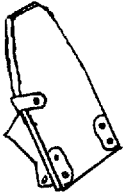
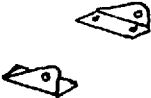

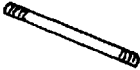

SPORTAVIA - Pützer
GmbH u. Co. KG.
D-5377 Post Schmidtheim

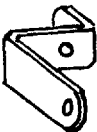

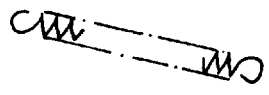

2. Rumpf - Fuselage
2.7 Flächen - und Leitwerksanschlüsse - Wing
and tailplane mountings - Ferrures de Fixation

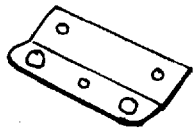
FOURNIER
- RF 4 D -
2.7

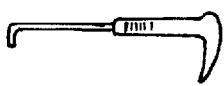
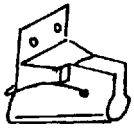
	Serien-No	Teile - Item - pièce	Anzahl Quantity
	4.22.03/B 4.22.03/C	Höhenruderbefestigung Elevator mounting Fixation plan fixe	1 1
	4.22.03/D	Gegenplatte Counter plate Contre-plaque	1
	4.22.03/E1 4.22.03/Er	Höhenruderbefestigung Elevator mounting Fixation plan fixe AR	1 1
	4.22.03/F	Befestigungsplatte Mounting plate Contre-plaque	2

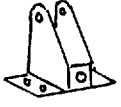
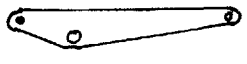
SPORTAVIA - Pützer GmbH u. Co. KG. D-5377 Post Schmidtheim		2. Rumpf - Fuselage 2.8 Steuerung - Control System - Commandes	FOURNIER - RF 4 D - 2.8
	Serien-No	Teile - Item - pièce	Anzahl Quantity
	4.23.14	Seitenruderpedal Rudder pedal Pédale de direction	2
	4.23.04/Br 4.23.04/B1	Winkel Mounting profile Charnière	2 2
	4.23.04/D	Gegenplatte Counter plate Contre-plaque	4
	4-23.04/E	Achse Shaft Axe	2
	4.23.02/A	Seilführung Control cable guidance guide cable	8
	4.23.02/B	Seilführung Control cable guidance guide cable	2
	4.23.02/C	Seilführung Control cable guidance guide cable	2
	4.23.04/A	Pedalbeschlag Pédal fitting Ferrure de pédale	2

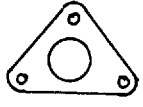

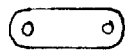
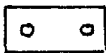
	Serien-No	Teile - Item - pièce	Anzahl Quantity
	42304/C	Gegenplatte Counter plate Contre plaque	4
	3.23.13	Ösenschraube Ring bolt Attache de ressort	2
	3.23.14	Zugfeder für Pedal Pedal spring Ressort de Pedale	2
	3.50.19	Gaszughalterung Throttle control mounting Support manette de gaz	1
	3.50.18	Halterung f. Starterklappen- und Brandhahnbetätigung Mixture control + Fuel cock con- trol mounting Support commande : starter - Robinet essence	1
	3.23.31	Trimmzughalterung Trim control mounting Support commande Flettner	1
	3.23.41	Handbremshebelstange Park brake lever Poignée de frein	1
	3.23.42/A	Handbremsführung Park brake control guidance Guide Poignée de frein	1



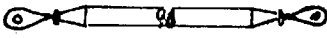
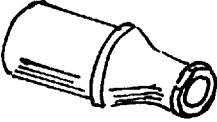

	Serien-No	Teile - Item - pièce	Anzahl Quantity
	3.23.44	Umlenkhebelträger Lever bearing Support guignol de frein	1
	3.23.43	Umlenkhebel für Bremszug Park brake control lever Guignol de frein	1
	3.23.45	Schelle Clamp Chappe	1
	4.23.26/A	Umlenkhebel Höhenruder Elevator lever Guignol de renvoi de profondeur	1
	4.23.03/C	Lagerplatte Bearing plate Plaque de fixation	2
	4.23.28	Anschlagbuchse Stop set Butée entretoise	2
	4.23.03/A	Gegenplatte Counter plate Contre plaque	2
	4.23.03/B	Gegenplatte Counter plate Contre plaque	2

SPORTAVIA - Pützer
GmbH u. Co. KG.
D-5377 Post Schmidtheim

2. Rumpf - Fuselage
2.8 Steuerung - Control System - Commandes

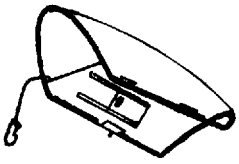
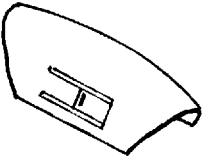
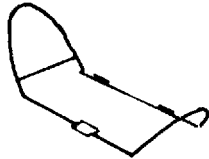
FOURNIER
- RF 4 D -
2.8



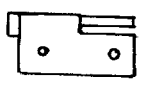



	Serien-No	Teile - Item - pièce	Anzahl Quantity
 2790	4.00.08	Höhenruderstoßstange Elevator push rod Bielle de Profondeur	1
	4.00.08/E	Stoßstangenkopf Push rod top Embout de bielle	2
	4.00.08/A4	Gabelkopf Crown joint Chape de bielle	2
	4.12.114	Stoßstangenführung Push rod guidance Guide bielle	1

SPORTAVIA - Pützer GmbH u. Co. KG. D-5377 Post Schmidtheim		2. Rumpf - Fuselage 2.9 Haube - Canopy - Verrière		FOURNIER - RF 4 D - 2.9
	Serien-No	Teile - Item - pièce	Anzahl Quantity	
	4.24.11	Haube vollständig Canopy completely Verrière	1	
	4.24.11/A2	Plexiglashaube Plexiglass Plexiglass	1	
	4.24.11/B	Haubenrahmen Canopy tube frame Armature	1	
	4.24.34	Griff Hand grip Poignee	1	
	4.24.35	Scharnier Hinge Charnon	2	
	4.24.36	Gewindebuchse Screw set Canon taraude	1	
	4.24.24	Buchse Set Canon	1	
	4.24.12	Scharnier Hinge Charniere	2	

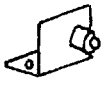
SPORTAVIA - Pützer
GmbH u. Co. KG.
D-5377 Post Schmidtheim

2. Rumpf - Fuselage
2.9 Haube - Canopy - Verrière

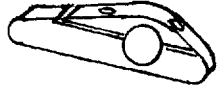
FOURNIER
- RF 4 D -
2.9

	Serien-No	Teile - Item - pièce	Anzahl Quantity
	4.24.15	Riegelbefestigungswinkel Lock mounting profile Support verrou	1
	4.24.13	Haubenriegel Canopy lock Verrou	1
	4.25.37	Sicherungsstift Safety pin Securité	1
	4.24.14	Zentrierbuchse Centrage set Canon de centrage	1
	4.24.17	Haubenabwurfriegel Emergency release lever Levier de largage	1
	4.25.28	Karabinerhaken Hook Mousqueton	1
	3.26.12	Seilhalterung Line mounting Attache sangle	1

SPORTAVIA - Pützer
GmbH u. Co. KG.
D-5377 Post Schmidtheim

2. Rumpf - Fuselage
2.10 Sporn - Tail wheel - Roulette

FOURNIER
- RF 4 D -
2.10

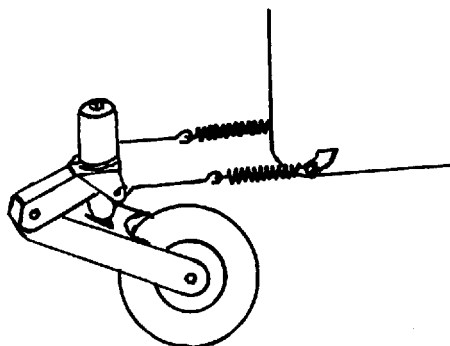

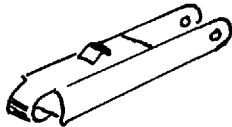
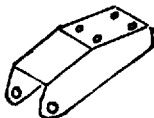
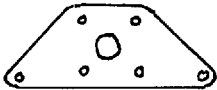





	Serien-No.	Teile - Item - pièce	Anzahl Quantity
Hülden	4.41.05	Spornrad Tail wheel Roulette	1
Paulstra 5.12.503	4.41.01/25	Gummipuffer Shock absorber Amortisseur	1
	4.41.02/B	Radgabel Wheel support Fourche de roulette	1
	4.41.02/C	Sporntraverse Tail wheel base Support de fourche	1
	4.41.02/E	Blech Sheet Guignol c ^{de} de roulette	1

SPORTAVIA - Pützer
GmbH u. Co. KG.
D-5377 Post Schmidtheim

2. Rumpf - Fuselage
2.10 Sporn - Tail wheel - Roulette

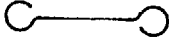

FOURNIER
- RF 4 D -
2.10

	Serien-No	Teile - Item - pièce	Anzahl Quantity
	4.41.03/A	Filzring Felt ring Rondelle feurre	1
	4.41.03/B	Scheibe Washer Rondelle	1
	4.41.03/C	Nylonscheibe Nylon disk Rondelle nylon	1
	4.41.03/D	Gegenplatte Counter plate Contre-plaque	1
	4.41.03/E	Gegenplatte Counter plate Contre-plaque	1
	4.41.03/F	Lasche Joint Rallonge	1
	4.41.03/G	Abdeckscheibe Cover disk Rondelle	1
	4.41.03/H	Federverlängerung Spring joint Rallonge de ressort	2

SPORTAVIA - Pützer
GmbH u. Co. KG.
D-5377 Post Schmidtheim

2. Rumpf - Fuselage
2.10 Sporn - Tail wheel - Roulette



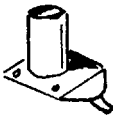



FOURNIER
- RF 4 D -
2.10



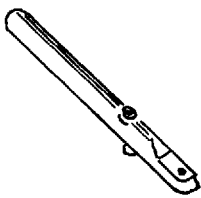
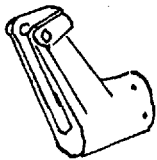

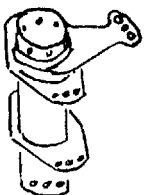
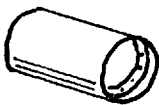
	Serien-No	Teil - Item - pièce	Anzahl Quantity
	4.41.13	Spornradfeder Tail wheel spring Ressort de roulette	2
	4.41.04/A	Spornlagerachse Tail wheel bearing Pivot	1
	4.41.01/26	Dämpfereinsatz Damper set Flexibloc	1
	4.41.04/C	Lagerbüchse Bearing set Corps	1
SKF 30.203	4.41.01/43	Kegelrollenlager Cone roller bearing Roulement	2



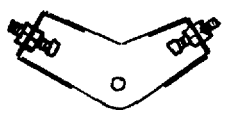
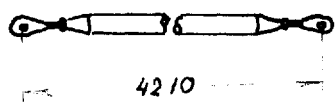
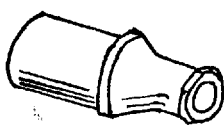
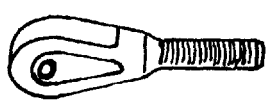

SPORTAVIA - Pützer
 GmbH u. Co. KG.
 D-5377 Post Schmidheim

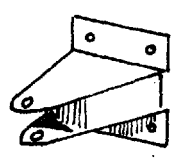
3. Tragfläche - Wing - Voilure
 3.1 Steuerung - Control system - Commandes

FOURNIER
 - RF 4 D -
 3.1

	Serien-No	Teil - Item - pièce	Anzahl Quantity
	4.23.20	Steuerknüppel Stick Manche	1
	4.12.66	Steuerknüppelfuß Stick bearing Embase de manche	1
	4.12.05/A	Buchse Set Canon	2
	4.12.03	Torsionsrohr komplett Control shaft, completely Tube de Torsion équipé	1
	4.12.63	Torsionsrohr komplett Torsion tube Tube de Torsion	
	4.12.64/B	Querruderantriebshebel Aileron control lever Guignol de manche	1
	4.12.64/C	Befestigung f. Querruderantriebs- hebel Aileron control lever mounting Fixation guignol de manche	1
	4.12.65	Anschlagbolzen Stop bolt Boulon de butée	1

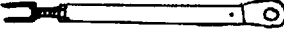
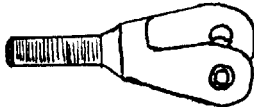
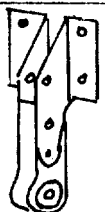
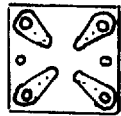

	Serien-No	Teil - Item - pièce	Anzahl Quantity
	4.12.62	Anschlagbegrenzung Aileron stop fitting Butée de gauchissement	1
ADR TRCE 50 E	4.12.03/15	Flanschlager Flange bearing Roulement	2
	4.00.08/B	Stoßstange Push rod Bielle de gauchissement	2
	4.00.08/E	Stoßstangenkopf Push rod top Embout de bielle	4
	4.00.08/A4	Gabelkopf Crown joint Chape	6
	4.12.114	Stoßstangenführung Pushrod guidance Guide bielle	2
	4.12.04/C	Umlenkhebelträger Lever bearing Support guignol de renvoi	2
	4.12.04/B	Gegenplatte Counter plate Contre plaque	4

	Serien-No	Teil - Item - pièce	Anzahl Quantity
	4.12.04/B	Umlenkhebel Lever Guignol de renvoi d'aileron	2
	4.12.05/B	Buchse Set Entreroise	2
	4.00.08/D	Querruderstoßstange Aileron push rod Bidle d'ailleron	2
	4.00.08./D2	Gabelkopf Crown joint Chape	2
	4.12.04/H	Querruderanschluß Aileron lever Guignol d'ailleron	2
	4.12.04/F	Gegenplatte Counter plate Contre plaque	2
	4.12.04/A	Querruderlager Aileron bearing Potence	6
	4.12.04/G1 4.12.04/Gr	Querruderlager Aileron bearing Charniere d'ailleron	6 6

SPORTAVIA - Pützer
GmbH u. Co. KG.
D-5377 Post Schmidheim

3. Tragfläche - Wing - Voilure
3.1 Steuerung - Control System - Commandes

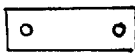
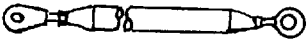

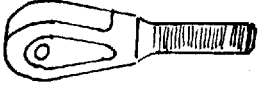



FOURNIER
- RF 4 D -
3.1

	Serien-No	Teil - Item - pièce	Anzahl Quantity
	4.12.04/E	Gegenplatte Counter plate Contre plaque	12
	4.00.08/A	Höhenruderstoßstange Elevator push rod Bielle de profondeur	1
	4.00.08/A3	Stoßstangenlagerkopf Push rod top Embout à rotulle	1
	4.00.08/B2	Gabelkopf Crown joint Chape	1

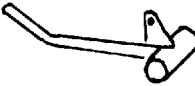
SPORTAVIA - Pützer
 GmbH u. Co. KG.
 D-5377 Post Schmidtheim

3. Tragfläche - Wing - Voilure
 3.2 Störklappen - Spoiler - Aérofreins

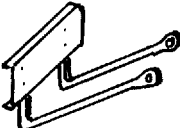

FOURNIER
 - RF 4 D -
 3.2



	Serien-No	Teil - Item - pièce	Anzahl Quantity
	3.13.14/B	Störklappenhebel Spoiler control lever Levier d'aerofrein	1
	3.13.16/B	Hebel Lever Guignol	1
	3.13.18/B	Hebel Lever Guignol	2
	3.13.20	Lasche Joint biellette	4
	3.13.21/A	Scheibe Plate Rondelle	2
	3.13.21/B	Scheibe Plate Rondelle	2
	4.13.01/9 4.13.01/10	Torsionsrohr Torsion tube Tube de Torsion d'aerofrein	1 2
	4.13.11/A	Störklappenschaufel Spoiler segment Palette d'aerofrein	6

SPORTAVIA - Pützer
GmbH u. Co. KG.
D-5377 Post Schmidtheim

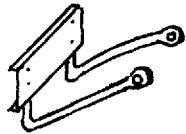
3. Tragfläche - Wing - Voilure
3.2 Störklappen - Spoiler - Aérofreins

FOURNIER
- RF 4 D -
3.2

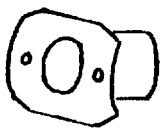
	Serien-No	Teil - Item - pièce	Anzahl Quantity
	4.13.11/Br 4.13.11/Bl	Störklappenschaufel außen Spoiler segment/outboard Palette extérieure	1 1
	4.15.11/B2	Störklappenblech Cover strip Chapeau d'aerofrein	2

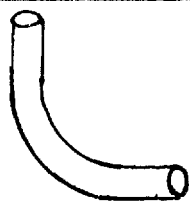
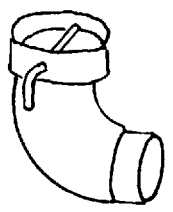

	Serien-No	Teil - Item - pièce	Anzahl Quantity
	3.71.12	Lufteintritt Cabin air intake Buse d'aeration	2
	3.71.17	Sieb Filter Filtre	2
	3.71.16	Rohr Tube tube	2
	3.71.13/L 3.71.13/r	Luftaustritt Cabin air exhaust Doseur d'aeration	2

SPORTAVIA - Pützer
 GmbH u. Co. KG.
 D-5377 Post Schmidtheim

3. Tragfläche - Wing -Voilure
 3.4 Stützbügel - Outrigger - Balancines

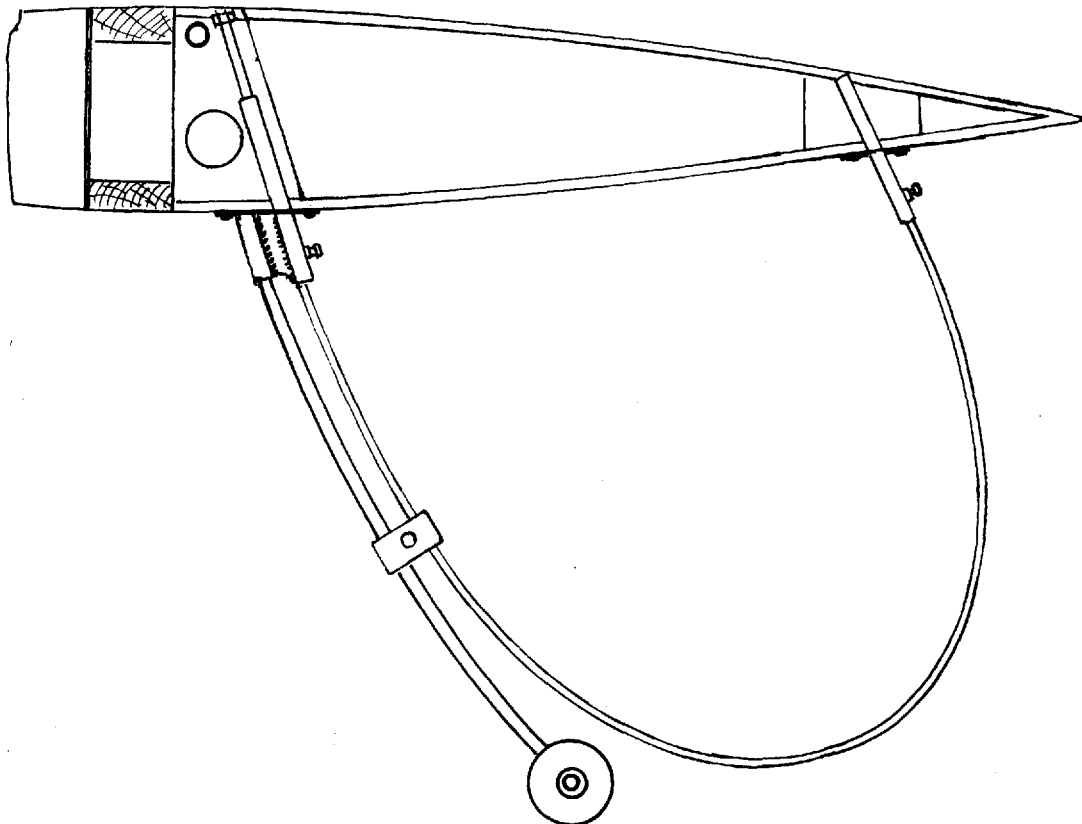
FOURNIER
 - RF 4 D -
 3.4

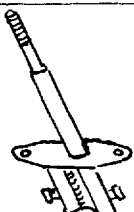
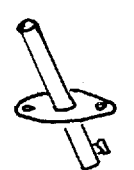



	Serien-No	Teil - Item pièce	Anzahl Quantity
	4.42.03	Stützbügelhalterung vorn Outrigger mounting front Support balancine avant	2
	4.42.02	Stützbügelhalterung Outrigger mounting aft Support balancine arriere	2
Federstahldraht 6 Ø' x 1200	4.42.01/3	Stützbügeldraht Wire Balancine	2
	4.42.04/B	Klemme Clamp Serre tringle	2

SPORTAVIA - Pützer
GmbH u. Co. KG.
D-5377 Post Schmidtheim

3. Tragfläche - Wing - Voilure
3,4 Stützbügel - Outrigger - Balancines

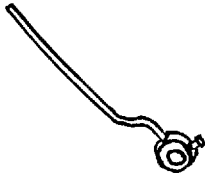

FOURNIER
- RF 4 D -
3.4



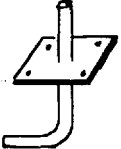
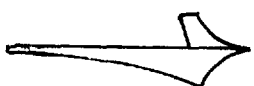

	Serien-No	Teil - Item - pièce	Anzahl Quantity
	4.42.04/B	Stützrollenbügel Wheel support Support roulette	2
	4.42.04/C	Stützrolle Wheel Roulette	2

SPORTAVIA - Pützer
GmbH u. Co. KG.
D-5377 Post Schmidheim

3. Tragfläche - Wing - Voilure
3.5 Verschiedenes - Various parts - Divers

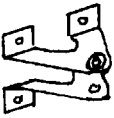
FOURNIER
- RF 4 D -
3.5



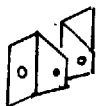
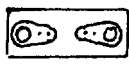
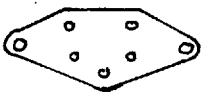

	Serien-No	Teile - Item - pièce	Anzahl Quantity
	4.70.11	Staurohr Pitot Prise rotale	1
Lift Detector Part-Nr. 164		Überziehwarnschalter Stall indicator Avertisseur	1
Marquardt 0 925.0201 10 A 250 V		Mikro-Schalter Microswitch Micro-contact	1
		Flächenverkleidung Wing cowling aft Carman d'aile	2
		Vordere Flächenverkleidung Wing cowling front Carman de bord d'attaque	2





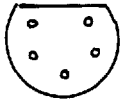

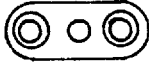
SPORTAVIA - Pützer GmbH u. Co. KG. D-5377 Post Schmidtheim	4. Leitwerk - Tailplane - Empennage 4.1 Seitenleitwerk- Vertical tail - Vertical		FOURNIER - RF 4 D - 4.1
	Serien-No	Teil - Item - pièce	Anzahl Quantity
	4.30.03/D 4.30.03/E	Befestigungswinkel Lower rudder bearing Charniere direction	1 1
	4.30.03/A	Steuerseilanschlußhebel Rudder lever Guignol de direction	1
	4.30.03/G	Distanzscheibe Distance disk Rondelle d'epaisseur	2
	4.30.03/G	Seitenruderlager Upper rudder bearing Charniere direction	1
	4.30.04/F	Gegenplatte Counter plate Contre plaque	1
	4.30.04/J	Winkel Mounting profile Charniere femelle	2
	4.30.04/F	Gegenplatte Counter plate Contre plaque	1
	4.30.03/B	Platte Plate Plaque	1



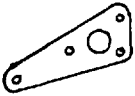
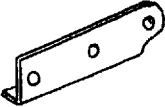

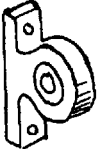
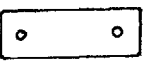

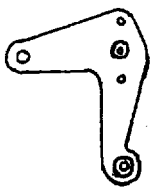
SPORTAVIA - Pützer
GmbH u. Co. KG.
D-5377 Post Schmidtheim

4. Leitwerk - Tailplane - Empennage
4.1 Seitenleitwerk-Vertical tail-Vertical

FOURNIER
- RF 4 D -
4.1

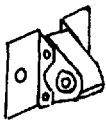
	Serien-No	Teil - Item - pièce	Anzahl Quantity
	4.30.03./C	Gegenplatte Counter plate Contre plaque	1
	4.41.15	Blech Lever sheet Guignol	1
	4.00.04/D	Gegenplatte Counter plate Contre plaque	1
	4.00.04/C	Befestigungsplatte Mounting plate Plaque de fixation	1
		Leitwerksverkleidung Fin cowling Carman de plan fixe	1

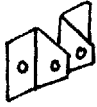
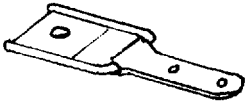

SPORTAVIA - Pützer GmbH u. Co. KG. D-5377 Post Schmidtheim		4. Leitwerk - Tailplane - Empennage 4.2 Höhenleitwerk - Empennage - horizontal	FOURNIER - RF 4 D - 4.2
	Serien-No	Teil - Item - pièce	Anzahl Quantity
	4.30.04/A	Höhenruderbefestigungslasche Elevator joint ferrure fixation plan fixe	1
	4.30.04/D	Höhenruderbefestigungslasche Elevator joint Ferrure fixation plan fixe	2
	4.30.04/E	Höhenruderbefestigungslasche Elevator joint Fixation plan fixe	2
	4.30.04/B	Höhenruderlager Elevator bearing Charniere centrale profondeur	1
	4.30.04/C	Platte Plate Plaque	1
	4.30.04/G	Gegenplatte Counter plate Contre plaque	1
	4.30.04/H	Höhenruderhebel Elevator lever Guignol profondeur	1
	4.30.04/K	Verbindungs-lagerlasche Bearing joint Biellette	1

SPORTAVIA - Pützer GmbH u. Co. KG. D-5377 Post Schmidheim		4. Leitwerk - Tailplane - Empennage 4.2 Höhenleitwerk - Empennage - horizontal		FOURNIER - RF 4 D - 4.2
	Serien-No	Teil - Item - pièce	Anzahl Quantity	
	4.32.114	Achse Shaft Axe	1	
	4.30.04/L	Distanzscheibe Distanc disk Rondelle d'epaisseur	2	
	4.30.04/M	Winkel Mounting profile Equerre	1	
	4.30.04/N	Höhenruderlager Elevator bearing Charniere profondeur	2	
	4.30.04/F	Gegenplatte Counter plate Contre plaque	4	
	4.30.04/I	Winkel Mounting profile Charniere femelle	2	
	3.32.32	Scharnier Trim tab hinge Charniere Tab	2	
	3.32.33	Hebel Trim tab lever Levier Tab	1	

SPORTAVIA - Pützer
 GmbH u. Co. KG.
 D-5377 Post Schmidtheim

4. Leitwerk - Tailplane - Empennage
 4.2 Höhenleitwerk - Empennage - horizontal

FOURNIER
 - RF 4 D -
 4.2

	Serien-No	Teil - Item - pièce	Anzahl Quantity
	3.32.34	Trimmzughalterung Trim control guidance Arret de gaine flettner	1
	4.32.13	Trimmruder Trim tab Tab	1
Jacottet		Trimmruderzug Trim control Commande flettner	1